

Concerning Compact Discs



Only compact discs bearing this mark can be used with this unit.

However, continued use of irregular shape CDs can damage the unit.



How to remove a disc from its case

How to store the disc in its case



How to hold a disc

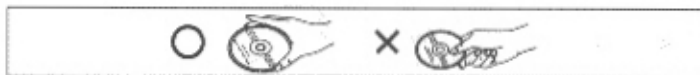

If the surface is dirty

Wipe it with a damp cloth and then wipe dry. Wipe from the center toward the outer circumference.

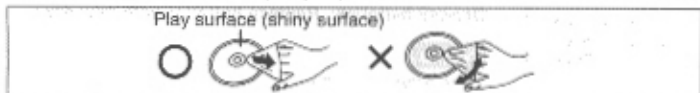

If moisture has formed on a disc

When moisture has formed because the disc was brought suddenly into a warm room from a cold environment, wipe it off using a soft dry cloth.

When storing discs

Avoid locations which are

- Exposed to direct sunlight.
- Susceptible to high levels of humidity or dust.
- Directly exposed to heat from a heating appliance.
- On top of a car dashboard or near the rear window.

Handling precautions

- On the label side (the side with writing) Do not write anything using a pencil, ball-point pen, etc. Do not stick paper or labels.
- On the disc (shiny) side Handle this side carefully to keep it free from fingerprints or scratches. Do not use record cleaners, solvents, etc.
- Do not attach labels or stickers to CD's.
- Do not use CDs with exposed adhesive from tape or left over stickers.
- Do not use scratch-proof protectors or covers other than those specified for use with this unit.

Portable CD player

Panasonic

Dear Customer

Thank you for purchasing this product. For optimum performance and safety, please read these instructions carefully.

The model number and serial number of this product can be found on either the back or the bottom of the unit.

Please note them in the space provided below and keep for future reference.

MODEL NUMBER _____
SERIAL NUMBER _____

Operating Instructions

SL-S202



Supplied Accessories

Check the packing carton for these accessories.

- | | |
|---|--|
| AC adaptor 1 pc. (RFEA415C-S) | For Canada Stereo earphones 1 pc. (RFEV317P-KS) |
| For U.S.A. Stereo headphones 1 pc. (RFEV705P-KS) | |

Use numbers indicated in parentheses when asking for replacement parts.
(Only for U.S.A.) To order accessories contact 1-800-332-5368 or web site (<http://www.panasonic.com>).

Before connecting, operating or adjusting this product, please read these instructions completely. Please save this manual.



Panasonic Consumer Electronics Company, Division of Matsushita Electric Corporation of America
One Panasonic Way Secaucus, New Jersey 07094 <http://www.panasonic.com>
Panasonic Sales Company, Division of Matsushita Electric of Puerto Rico, Inc. ("PSC")
Ave. 65 de Infanteria, Km. 9.5 San Gabriel Industrial Park, Carolina, Puerto Rico 00985
Panasonic Canada Inc.
5770 Ambler Drive, Mississauga, Ontario L4W2T3 www.panasonic.ca



RQT4990-P
F1198R0 (D)

Precautions

Before using this unit, be sure to read the applicable items of the operating instructions and these safety suggestions carefully.

Afterwards keep them handy for future reference. Take special care to follow the warnings indicated on the unit itself as well as in the operating instructions.

Safety

- 1. Power Source**—The unit should be connected to power supply only of the type described in the operating instructions or as marked on the unit. Use only the AC adaptor or car adaptor described in the operating instructions when recharging.
- 2. Polarization**—If the unit is equipped with a polarized AC power plug (a plug having one blade wider than the other), that plug will fit into the AC outlet only one way. This is a safety feature. If you are unable to insert the plug fully into the outlet, try reversing the plug. If the plug should still fail to fit, contact your electrician to replace your obsolete outlet. Do not defeat the safety purpose of the polarized plug.
- 3. Care of AC adaptor**—Take care that the cord of the AC adaptor should be routed so that they are not likely to be walked on or pinched by items placed upon or against them. Never take hold of the AC adaptor if your hand is wet, and always grasp the plug body when connecting or disconnecting it.
- 4. Nonuse Periods**—When not in use, be sure to disconnect the AC adaptor from the AC power outlet.
- 5. Batteries**—If the set is not used for a long period of time or is used only from an AC power source, remove all the batteries to prevent potential damage due to possible battery leakage. Do not mix batteries (old and new) or different types of batteries.

Installation

Environment

- 1. Water and Moisture**—Do not use this unit near water—for example, near a bathtub, washbowl, swimming pool, or the like. Damp basements should also be avoided.
- 2. Condensation**—Moisture may form on the lens in the following conditions...
 - immediately after a heater has been turned on.
 - in a steamy or very humid room.
 - when the unit is suddenly moved from a cold environment to a warm one. If moisture forms inside this unit, it may not operate properly. To correct this problem wait about one hour for the moisture to evaporate.
- 3. Heat**—Never use or place this unit near a heat source. Do not leave it in an automobile exposed to direct sunlight for a long time with the doors and windows closed as this may deform the cabinet.

Placement

- 1. Foreign Material**—Care should be taken so that objects do not fall into and liquids are not spilled into the unit. Do not subject this unit to excessive smoke, dust, mechanical vibration, or shock.
- 2. Magnetism**—The unit should be situated away from equipment or devices that generate strong magnetic fields.
- 3. Stacking**—Do not place any objects, on top of the unit.

Maintenance

(See page 7 for details.)

Clean the cabinet, panel and controls with a soft cloth lightly moistened with mild detergent solution. Do not use any type of abrasive pad, scouring powder or solvent such as alcohol or benzene.

Service

- 1. Damage Requiring Service**—The unit should be serviced by qualified service personnel when:
 - (a) The AC adaptor is damaged; or
 - (b) Objects have fallen or liquid has been spilled into the unit; or
 - (c) The unit has been exposed to rain; or
 - (d) The unit does not appear to operate normally or exhibits a marked change in performance; or
 - (e) The unit has been dropped, or the enclosure damaged.
- 2. Servicing**—The user should not attempt to service the unit beyond that described in the operating instructions. All other servicing should be referred to an authorized service personnel.
For the address of an authorized servicer:
In the U.S.A. 1-800-211-7262 or web site (<http://www.panasonic.com>)
In Canada 905-624-5505 or web site (www.panasonic.ca/fdbckca.htm)



This manual was printed with soy based ink.

Power Supply Preparations

Refer to the specifications (page 8) for information on operating times when using rechargeable batteries or dry-cell batteries.

Using the AC adaptor

Connect the AC adaptor supplied.

DC IN jack (⊕ ⊖ ⊕ DC IN 4.5 V)

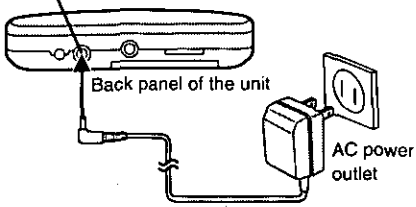

Using rechargeable batteries (not included)

Obtain the optional rechargeable batteries. Make sure to recharge the batteries before using them. The unit cannot be used to charge rechargeable batteries other than those specially designed for it.

• Optional batteries (P-3GAVA/2B, SH-CDB8D)

Recharging procedure

1 Insert the special rechargeable batteries into the unit.

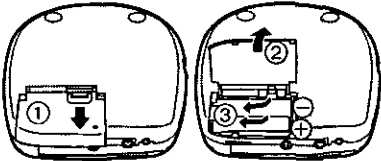

2 Connect the AC adaptor.

Refer to "Using the AC adaptor" for connection instructions.

3 When recharging is complete, unplug the AC adaptor from the power outlet and the DC IN jack.

Notes

- Rechargeable batteries have a service life of approximately 300 charge-discharge cycles. If the operating time on one full charge becomes noticeably shorter than it used to be, the battery has reached the end of its service life and should be replaced.
- You can operate the unit with the AC adaptor while recharging the batteries, but it will lengthen the recharging time.
- The AC adaptor and rechargeable batteries may become warm while recharging is in progress. This is not a malfunction.

If the battery lid comes loose
Slide the lid back into place horizontally.

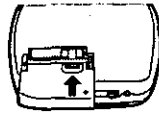

Removing batteries
Push up on the battery in the direction indicated by the arrow. Then lift it out.

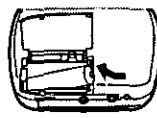

Using the car adaptor (not included)

Be sure to obtain the car adaptor (SH-CDC9), available as an optional accessory. The car adaptor can be used to recharge the unit's batteries while in the car.

CAUTION:

Use only car adaptor, Model: SH-CDC9 manufactured by Matsushita Electric Industrial Co., Ltd.

Using dry-cell batteries (not included)

After disconnecting the AC adaptor, insert two "AA" (LR6) alkaline batteries.

The procedure for inserting and removing dry-cell batteries is identical to that for rechargeable batteries.

Battery indicator



This indicator flashes on and off when the batteries are almost out of power. Power is cut off completely a short while later.

Rechargeable batteries: Recharge batteries.

Dry-cell batteries: Replace batteries with new ones.

Notes

- The length of time the unit will continue to operate between when the battery indicator starts flashing and when the power is cut off differs depending on the type of batteries used.
- The battery indicator may not flash if rechargeable batteries, other than those designated by Panasonic, are used.

If the unit malfunctions or freezes during use, then disconnect the power sources (the AC adaptor and batteries).

Re-connect the power source and continue operation.

HOLD Function

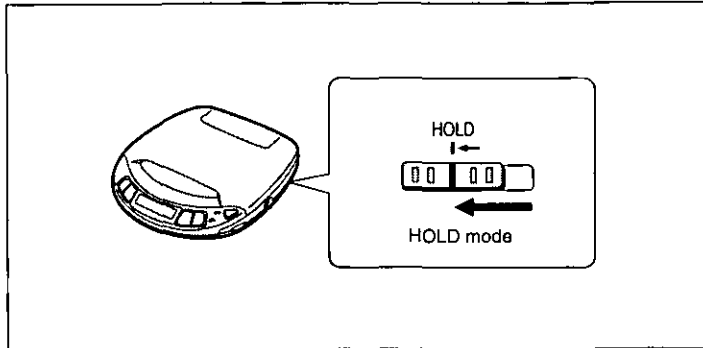

This function causes the unit to ignore short, accidental button presses. (The disc lid can still be opened and closed.)

The HOLD function prevents the following:

- Powering on the unit accidentally (which can cause the batteries to go dead).
- Play being cut off unexpectedly in the middle of a selection.

To use the HOLD function

Set HOLD to the HOLD position.

"hold" indication

When the unit is in hold status, pressing any button (other than the OPEN button) causes the indication "hold" to appear on the display.

When the unit is powered off

The "hold" indication appears only when ►|| button is pressed.

Before operating the buttons

Be sure to move HOLD to release the unit from the hold mode.

Location of Controls

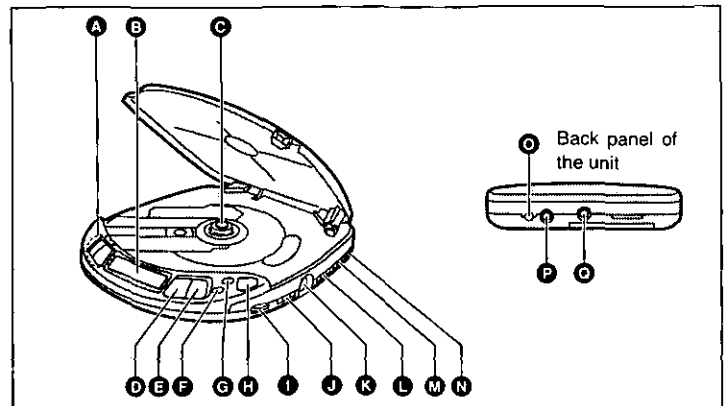

- A** Skip/search buttons (◀◀, ▶▶) • SKIP = SEARCH
- B** Display
- C** CD release button (PUSH)
- D** Play/pause button (▶ ||)
- E** Stop/power off button (■, POWER OFF)
- F** Memory/recall button (MEMORY/RECALL)
- G** Repeat button (REPEAT)
- H** Open button (OPEN)
- I** Headphones volume control (VOLUME)

- J** XBS selector (XBS)
- K** Headphones jack (◻)
- L** Play mode selector (RESUME, NORMAL, RANDOM)
- M** Hold switch (HOLD)
- N** Anti-shock switch (ANTI-SHOCK)
- O** Out jack (OUT)
- P** DC in jack (⊕ ⊖ ⊕ DC IN 4.5 V)
- Q** Hole for car insulator mounting screw

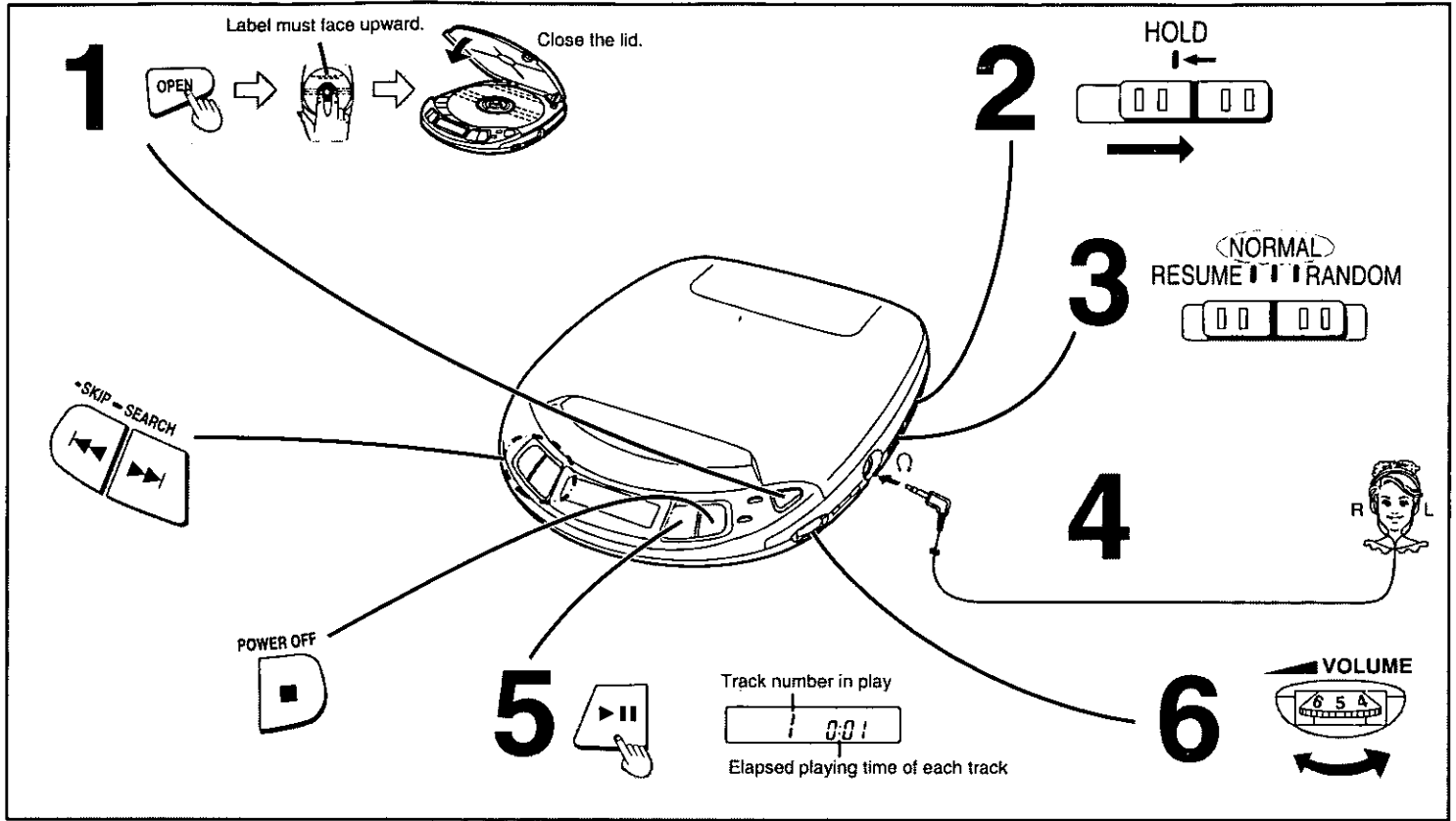

Follow steps 1-6.

In step 4, connect the stereo headphones/earphones to the jack. (Plug in firmly.)

- Play stops automatically when all the tracks have been played.
- If the unit has been connected to the car audio system, adjust the volume level between 4 and 6 on the unit, then adjust the volume level on the system.

For your reference:

"no disc" indication

This indication appears for about 30 seconds if the button is pressed when no disc is loaded in the unit or if the disc is not completely seated.

"OPEN" indication

This indication appears for about 10 minutes when the cover is opened. (However, the indication does not appear when the unit is powered off.)

Note

Never insert foreign objects into the unit body.

Removing discs

After the disc has stopped rotating, press the button to release the disc. (To protect the disc, never open the cover while it is playing.)

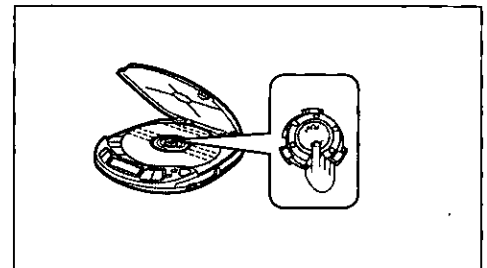

Auto power off function

If the unit is left in stop or paused status for approximately 10 minutes, the unit powers itself off automatically in order to prevent the battery from running down. (If no disc is loaded in the unit, it powers itself off in 30 seconds.)

| Operation | Button | Display/reference |
|---|--|--|
| To pause play | Press during play. | Press again to resume play. |
| To stop play Stop mode | Press during play. | Total number of tracks Total playing time |
| To turn off the unit Off mode | Press during stop mode. | |
| Skip forward/ backward (skip function) | Press during play. (Backward) (Forward) | <ul style="list-style-type: none"> • During program play (page 4), these buttons are used to skip forward or back through the programmed sequence of tracks. • During random play (page 4), the skip buttons cannot be used to skip back to tracks that were played previously in the random sequence. • During program play, random play or 1 track repeat play (page 4), search operation is limited to the current track only. |
| Rapid forward/ backward (search function) | Keep depressed during play. | |

Other Play Methods

The letters such as **A** in the various illustrations refer to the descriptions in the "Location of Controls" section (see page 2).

Skip play

The disc plays from the specific track through to the end, then play stops automatically.

Preparation: Put unit in stop mode.

1

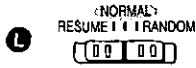

2 Select the desired track.

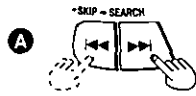

3



Random play

1

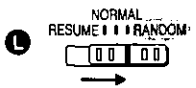

2



Release



For your reference:

- It is also possible to press the **▶▶** button while the unit is in stop status to change the first track to be played. (All tracks are played eventually, regardless of which is played first.)
- Program play is not possible in the random mode.

Resume play

This function allows you to listen from the beginning of the track where play stopped because the unit was powered off (or switched to stop status). It is useful when listening to CDs in the car, etc.



Release

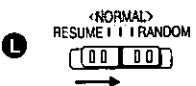

For your reference:

- If the RESUME, NORMAL, RANDOM (play mode) slider is put in the RESUME position, the all-repeat function will be activated automatically as soon as the unit is powered on.
- If power is cut off near the end of a track (power off status), playback may resume from the beginning of the next track.
- If the unit is powered off while a disc was playing and then a new disc is inserted, play will begin from the middle of the new disc because the unit remembers the position where play stopped on the old disc.

Program play

Up to 24 tracks can be entered in the programmed sequence.

Preparation: Put unit in stop mode.

1



2 Select the desired track.



3 Register in sequence.

(The indication "M" and the programmed sequence appear on the display panel.)



4 Repeat steps 2 and 3 to program all the desired tracks.

5



- **To program the same track in the sequence more than once**
After step 3, press MEMORY/RECALL the desired number of times.

- **If "f" is displayed**
No more tracks can be programmed.

- **To confirm the contents of the program**
Press MEMORY/RECALL while the disc is playing. (The number of the programmed tracks appear on the display panel in sequence.)

- **To delete the entire programmed sequence**
Press **■**, POWER OFF.

Repeat function

Press REPEAT while disc is playing or when unit is in stop status.



For your reference:

If REPEAT is pressed during program play, only the tracks in the program are repeated. (The indication "ALL" is not displayed.)

The setting is switched in the sequence indicated below each time REPEAT is pressed.

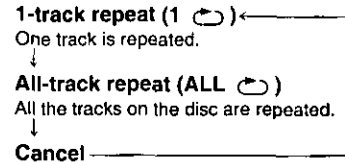

Changing the sound quality

XBS ON:

Select this setting to boost the low-range response.



OFF:

Select this setting to turn off the XBS function.

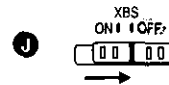

Note

This function is not available when using the OUT jack.

Anti-Shock Function

This function minimizes sound interruption when vibrations are encountered by utilizing audio data that has been stored ahead of time (up to approximately 3 seconds worth).

1



2



| M.RESERVE indicator status | Unit body status | Play status (audio data status) |
|----------------------------|---------------------------|--|
| | Stable | Normal (plenty of data is stored) |
| | Bump encountered | Normal (stored data is used) |
| | Bumping stops | Normal (data again starts to be stored) |
| | Bumps continue repeatedly | Sound is interrupted (data buffer empty) |

Notes

- The position of the ANTI-SHOCK slider can be changed during play, but this may cause a slight interruption in the sound because the disc's rotation speed changes.
- During anti-shock operation, the disc rotates at a higher rate than usual in order to collect extra audio data. This may cause the batteries to run out faster and could result in a slight increase in disc rotation noise.

Using the unit with an audio system

The anti-shock uses digital signal compression technology. It is recommended that the ANTI-SHOCK be kept in the OFF position if the unit is connected to a home audio system.

Using the Unit with Optional Accessories

Using the unit with an audio system

Using stereo connection cable (not included), you can hear CDs on your audio system.

- Connect the cable to the amplifier after turning off its power.
- Do not connect the cable to the PHONO jacks on the amplifier.
- Obtain the optional connecting cable if the amplifier comes with mini-phone jacks.
- Adjust the volume on the amplifier.

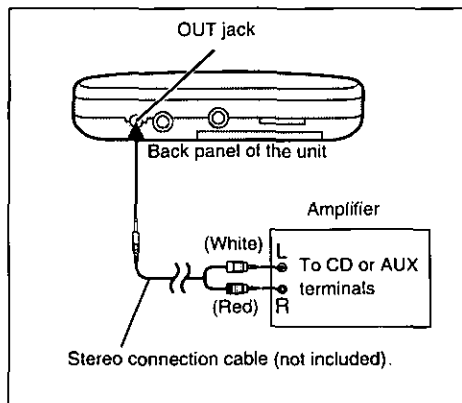

Using the unit with a car audio system stereo

Items to be purchased

For connection to the car audio system:
Car stereo cassette adaptor (SH-CDM10A)

Connect the car stereo cassette adaptor to the unit's headphones jack. (When doing this, keep the unit's VOLUME control at a setting between 4 and 6.)

For securing the unit and connecting the power supply:

- Car adaptor (SH-CDC9)
- Car mounting kit (SH-CDF7)
- Car mounting arm, Car insulator

Note

It may not be possible to use the unit with some types of car stereos owing to restrictions imposed by the construction of the car stereo cassette adaptor.

For further details, refer to the instructions of the part concerned.

Panasonic Consumer Electronics Company, Division of Matsushita Electric Corporation of America
One Panasonic Way,
Secaucus, New Jersey 07094
http://www.panasonic.com

ONLY FOR U.S.A.

Panasonic Sales Company, Division of Matsushita Electric of Puerto Rico, Inc. ("PSC")
Ave. 65 de Infantería, Km. 9.5
San Gabriel Industrial Park
Carolina, Puerto Rico 00985
Tel. (809) 750-4300
FAX. (809) 768-2910
Limited Warranty

Panasonic Limited Warranty

Panasonic Consumer Electronics Company or Panasonic Sales Company (collectively referred to as "The warrantor") will repair this product with new or refurbished parts, free of charge, in the U.S.A. or Puerto Rico from the date of original purchase in the event of a defect in materials or workmanship as follows:

For one (1) year—Radio, Clock Radio, Radio with Tape Player or Recorder, Speaker

For ten (10) days—Batteries—(when applicable)—New rechargeable batteries in exchange for defective rechargeable batteries. Non-rechargeable batteries are not warranted.

For assistance in the U.S.A. in obtaining repairs contact:

**Panasonic Services Company
Panasonic PLUS Department**
20421 84th Avenue South
Kent, WA 98032
Phone: 1-800-833-9626
FAX: 1-800-237-9080

If repair is needed, during the warranty period the purchaser will be required to furnish a sales receipt/proof of purchase indicating date of purchase.

Also, the purchaser will be responsible for shipping the unit to the above address. This warranty is extended only to the original purchaser.

For assistance in Puerto Rico contact, Panasonic Sales Company at the address or telephone number above.

This warranty only covers failures due to defects in materials or workmanship which occur during normal use and does not cover damage which occurs in shipment or failures which are caused by products not supplied by the warrantor or failures which result from accident, misuse, abuse, neglect, mishandling, misapplication, faulty installation, set-up adjustments, improper maintenance, alteration, improper antenna, inadequate signal pick-up, maladjustment of consumer controls, modification, line power surge, or commercial, use of the product, or damage that is attributable to acts of God, or service by anyone other than a PASC Factory Servicenter.

LIMITS AND EXCLUSIONS

There are no express warranties except as listed above.

THE WARRANTOR SHALL NOT BE LIABLE FOR INCIDENTAL OR CONSEQUENTIAL DAMAGES RESULTING FROM THE USE OF THIS PRODUCT, OR ARISING OUT OF ANY BREACH OF THIS WARRANTY, INCLUDING WITHOUT LIMITATION, DAMAGE TO TAPES, RECORDS OR DISCS. ALL EXPRESS AND IMPLIED WARRANTIES, INCLUDING THE WARRANTIES OF MERCHANTABILITY, ARE LIMITED TO THE APPLICABLE WARRANTY PERIOD SET FORTH ABOVE. Some states do not allow the exclusion or limitation of incidental or consequential damages, or limitations on how long an implied warranty lasts, so the above exclusions or limitations may not apply to you.

This warranty gives you specific legal rights and you may also have other rights which vary from state to state.

If a problem with this product develops during or after the warranty period, you may contact your dealer or Panasonic PLUS Department. If the problem is not handled to your satisfaction, then write to the Customer Satisfaction Center at the company address above or call toll free 1-800-211-7262.

If you ship the product

Carefully pack and send it prepaid, adequately insured and preferably in the original carton. Attach a letter, detailing the complaint, to the outside of the carton.

Do NOT send the product to the Executive or Regional Sales offices. They are NOT equipped to make repairs.

Customer's Record

Model
No. _____

Dealer's
Name _____

Serial
No. _____
or

Code
No. _____

Dealer's
Address _____

Date
of
Purchase _____

Product Service

Do not attempt to remove the cover(s) or repair the unit yourself. Refer servicing to qualified personnel only.

Product information

For product service, product information or assistance with product operation, refer to the servicenter directory.

User memo:

DATE OF PURCHASE _____
DEALER NAME _____
DEALER ADDRESS _____
TELEPHONE NUMBER _____

Maintaining the Lens

Open the lid and clean the lens as shown in the figure. Use a cotton swab to gently wipe off any finger-prints. Recommended product: Lens cleaner kit (SZZP1038C)

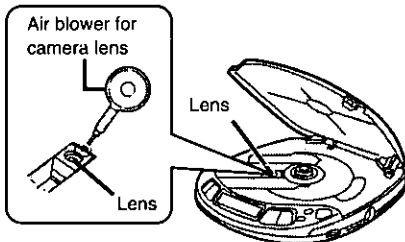

WARNING:

TO REDUCE THE RISK OF FIRE, ELECTRIC SHOCK OR PRODUCT DAMAGE, DO NOT EXPOSE THIS APPLIANCE TO RAIN, SPLASHING, DRIPPING OR MOISTURE.

CAUTION!

THIS PRODUCT UTILIZES A LASER. USE OF CONTROLS OR ADJUSTMENTS OR PERFORMANCE OF PROCEDURES OTHER THAN THOSE SPECIFIED HEREIN MAY RESULT IN HAZARDOUS RADIATION EXPOSURE. DO NOT OPEN COVERS AND DO NOT REPAIR YOURSELF. REFER SERVICING TO QUALIFIED PERSONNEL.

The product you have purchased is powered by a nickel-cadmium battery which is recyclable.

Please call 1-800-8-BATTERY for information on how to recycle this battery.



THE FOLLOWING APPLIES ONLY IN THE U.S.A.:

CAUTION:

This equipment has been tested and found to comply with the limits for a Class B digital device, pursuant to Part 15 of the FCC Rules.

These limits are designed to provide reasonable protection against harmful interference in a residential installation. This equipment generates, uses and can radiate radio frequency energy and, if not installed and used in accordance with the instructions, may cause harmful interference to radio communications. However, there is no guarantee that interference will not occur in a particular installation. If this equipment does cause harmful interference to radio or television reception, which can be determined by turning the equipment off and on, the user is encouraged to try to correct the interference by one of the following measures:

- Reorient or relocate the receiving antenna.
- Increase the separation between the equipment and receiver.
- Connect the equipment into an outlet on a circuit different from that to which the receiver is connected.
- Consult the dealer or an experienced radio/TV technician for help.

Any unauthorized changes or modifications to this equipment would void the user's authority to operate this device.

This device complies with Part 15 of the FCC Rules. Operation is subject to the following two conditions: (1) This device may not cause harmful interference, and (2) this device must accept any interference received, including interference that may cause undesired operation.

Specifications

Audio
 No. of channels: 2 (left and right, stereo)
 Frequency response: 20 to 20,000 Hz (+0.5 dB to -1.5 dB)
 Output voltage: 0.6 V (50 kΩ)
 S/N: More than 94 dB*
 Wow and flutter: Below measurable limit
 DA converter: 1 bit, MASH
 Headphones output level: Max. 9 mW+9 mW/16Ω (adjustable)

Pickup
 Light source: Semiconductor laser
 Wavelength: 780 nm

General
 Operational temperature range: 0°C-40°C (32°F-104°F)

Rechargeable temperature range: 5°C-40°C (41°F-104°F)

Power supply: DC 4.5 V
 Power consumption:

| Power source | Anti-shock OFF/ON |
|--------------|-------------------|
| AC adaptor | 4.3 W/4.5 W |

Play time:
 [When used in hold mode, at 25°C (77°F) temperature and on flat and stable surface]

| Batteries used | Anti-shock OFF/ON |
|--|-------------------|
| 2 alkaline batteries | About 10 h/8.5 h |
| Optional rechargeable batteries (P-3GAVA/2B) | About 5.5 h/5.0 h |

The play time may be less depending on the operating conditions.

Recharging time:
 P-3GAVA/2B: About 5 hours
 SH-CDB8D: About 3 hours

Dimensions (W×H×D): 128×28.0×144 mm (5 1/16"×1 1/2"×5 1/16")
 Weight: 265 g (9.4 oz.) (with batteries)
 220 g (7.8 oz.) (without batteries)

*These specifications were measured in the anti-shock OFF mode.

Note:
 Specifications are subject to change without notice.
 Weight and dimensions are approximate.

Troubleshooting Guide

Before requesting service for this unit, check the chart below for a possible cause of the problem you are experiencing. Some simple checks or a minor adjustment on your part may eliminate the problem and restore proper operation. If you are in doubt about some of the check points, or if the remedies indicated in the chart do not solve the problem, refer to the directory of Authorized Service Centers (enclosed with this unit) to locate a convenient service center, or consult your dealer for instructions.

For detailed instructions, contact an authorized servicer in the U.S.A. and Panasonic Canada Inc. Customer Care Centre in Canada.
 In the U.S.A. 1-800-211-7262 or web site (<http://www.panasonic.com>)
 In Canada 905-624-5505 or web site (www.panasonic.ca/faq.html)

| Problem | Check this |
|---|--|
| Cannot close cover. | Is the disc properly secured in place? |
| Cannot play discs. | <ul style="list-style-type: none"> Is the unit in hold status? Is the disc properly secured in place? Is there condensation on the lens? (Wait for about an hour and then try again.) |
| Cannot remove disc. | Did you press the PUSH button to release the disc? |
| Tracks on disc do not play in order, starting with the first track. | Is the RESUME, NORMAL, RANDOM (play mode) slider in the NORMAL position? |
| Cannot hear music—too noisy. | <ul style="list-style-type: none"> Is the headphones/earphones plug inserted all the way? Is the plug dirty? (Wipe away dirt on plug.) |
| TV picture is distorted. Radio reception is noisy. | Are you using the unit body too near a TV or tuner? (If the TV or tuner is connected to a simple indoor antenna, connect it to an outdoor antenna.) |

Cautions

Listening caution



Do not play your headphones or earphones at a high volume. Hearing experts advise against continuous extended play.

If you experience a ringing in your ears, reduce volume or discontinue use.

Do not use while operating a motorized vehicle. It may create a traffic hazard and is illegal in many areas.

You should use extreme caution or temporarily discontinue use in potentially hazardous situations.

Even if your headphones or earphones is an open-air type designed to let you hear outside sounds, don't turn up the volume so high that you can't hear what's around you.

Sound can be deceiving. Over time your hearing "comfort level" adapts to higher volumes of sound. So what sounds "normal" can actually be loud and harmful to your hearing. Guard against this by setting your equipment at a safe level BEFORE your hearing adapts.

To establish a safe level:
 • Start your volume control at a low setting.
 • Slowly increase the sound until you can hear it comfortably and clearly, and without distortion.

Once you have established a comfortable sound level:
 • Set the dial and leave it there.

Rechargeable batteries

- Only the P-3GAVA/2B, SH-CDB8D batteries can be recharged.
- If the power delivered by the batteries lasts for a very short time after recharging, it means that the batteries' service life is over. Do not use them any more.
- Recharging already charged batteries will shorten their service life.
- When recharging batteries for the first time or when they have not been used for a long period of time, the play time may be shorter than usual. In a case like this, repeatedly recharge and discharge the batteries. This will restore them to their regular state.
- Do not allow any metal objects to touch the terminals of rechargeable batteries since this may cause short-circuiting which is dangerous.
- Do not peel off the plastic covering on the rechargeable batteries. Short-circuiting may occur which is dangerous.

Dry cell batteries/rechargeable batteries

To prevent damage to the batteries and electrolyte leakage, heed the following points.

- Align the ⊕ and ⊖ polarities properly when inserting the batteries.
- Do not mix different types or makes of batteries or old and new batteries.
- Remove the batteries if you do not plan to use the unit for a long period of time.
- Do not throw batteries into a fire, and do not short-circuit, disassemble or subject them to excessive heat.
- Do not attempt to recharge dry cell batteries.

Carrying dry cell batteries/rechargeable batteries around

When putting dry cell or rechargeable batteries in a pocket or bag, ensure that no other metal objects such as a necklace are placed together with them. Contact with metal may cause short-circuiting which, in turn, may cause a fire. Be absolutely sure to carry the rechargeable batteries in the battery carrying case.

When purchasing rechargeable batteries

As a safety precaution, the portable CD players made by Panasonic have a construction designed to make it impossible to recharge ordinary batteries.

To use rechargeable batteries, be absolutely sure to purchase the rechargeable Ni-Cd batteries designed especially for this unit.

Special rechargeable Ni-Cd batteries:
 P-3GAVA/2B, SH-CDB8D (set of 2)

For details, check with your dealer.

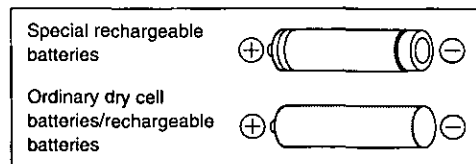

When driving a car

In the interest of traffic safety, do not operate the unit while driving.